

**CODE NUMBER**

3911306

**DESCRIPTION**

3.5 gpf, Rough Brass Finish, Rear Spud, Single Flush, 1" Straight Control Stop, 8.75 L Dimension, Royal® Concealed Manual Water Closet Flushometer.

**DETAILS**

- Flush Volume: 3.5 gpf (13.2 Lpf)
- Finish: Rough Brass (RB)
- Valve: Diaphragm
- Valve Body Material: Semi-red Brass
- Fixture Type: Water Closet
- Fixture Connection: Rear Spud
- Rough-In Dimension: 14 ½" (368mm)
- Spud Coupling: 1 ½" (38mm)
- Supply Pipe: 1" (25mm)
- L Dimension: 8 ¾" (222mm) (8-3/4-LDIM)
- Control Stop: 1" Straight (E)

**FEATURES**

- Flush volumes start as low as 1.28 gpf/4.8 Lpf
- Water conservation is aided by the ADA-compliant, non-hold-open handle, which prevents toilet from exceeding intended flush volume
- Flush accuracy is controlled by CID™ technology, also enhancing water efficiency
- Integrity of the product is maintained with the vandal-resistant stop cap
- Durability is facilitated with high copper, low zinc brass castings for dezincification resistance
- Adjustable tailpiece
- PERMEX synthetic rubber diaphragm with Dual Filtered Fixed Bypass
- Valve body, Cover, Tailpiece and Control Stop shall be in compliance with ASTM Alloy Classification for Semi-Red Brass
- Valve shall be in compliance to the applicable sections of ASSE 1037.

**COMPLIANCES & CERTIFICATIONS**

(ADA Compliant, UPC Certified, BAA Compliant)

**RECOMMENDED SPECIFICATION**

Valve Body, Cover, Tailpiece and Control Stop shall be in conformance with ASTM Alloy Classification for Semi- Red Brass. Valve shall be in compliance with the applicable sections of ASSE 1037 and ANSI/ASME 112.19.2.

**VALVE OPERATING PRESSURE (FLOWING)**

15–80 PSI (103–552 kPa). Specific fixtures may require greater minimum flowing pressure - consult manufacturer requirements.

**DOWNLOADS**

- [Sloan Concealed Installation Instructions](#)
- [Control Stop Repair and Maintenance Guide](#)
- [Flush Connections Flanges Repair and Maintenance Guide](#)
- [Tail Piece Repair and Maintenance Guide](#)
- [Concealed Flushometers Repair and Maintenance Guide](#)
- [Additional Downloads](#)

**NOTES**

All information contained within this document subject to change without notice.

Looking for other variations of the ROYAL 143 product? [View the general spec sheet with all options.](#)

[Find a compatible urinal](#) for this flushometer.

[Find a compatible water closet](#) for this flushometer.

Sloan 10500 Seymour Ave, Franklin Park, IL 60131

Phone: 800.982.5839 • Fax: 800.447.8329 • [sloan.com](http://sloan.com)

**ROUGH-IN**

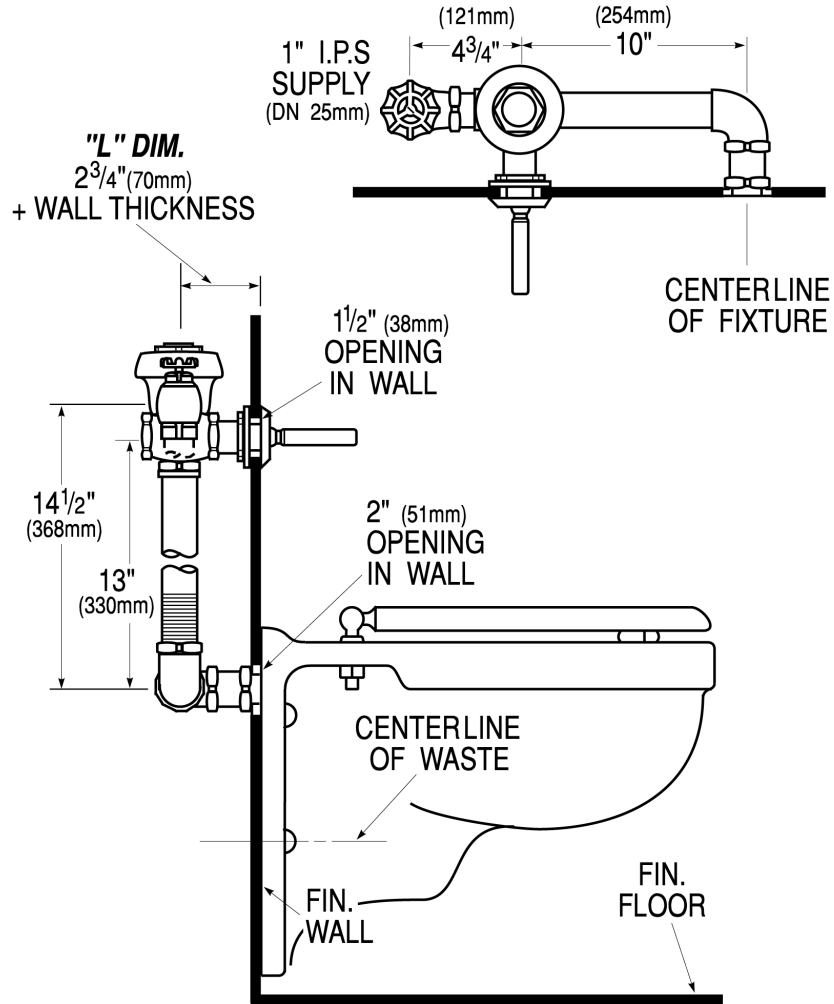

Sloan 10500 Seymour Ave, Franklin Park, IL 60131  
Phone: 800.982.5839 • Fax: 800.447.8329 • [sloan.com](http://sloan.com)